

- 2X 2070
- 2X 1881
- 2X 1884
- 1X 1890
- 1X 2238
- 1X 2239

- 2X 1885

- 1X 1886

- 1X 1888

- 1X 1644

(B) 24X

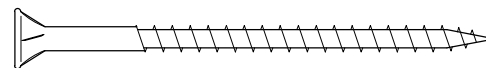

2 1/2" #8 FLAT HEAD (#2 ROBERTSON)
2 1/2 PO TÊTE PLATE NO 8 (no 2 ROBERTSON)

(F) 28X

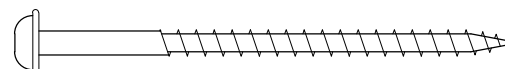

2 1/2" BLACK PAN HEAD ROBERTSON SCREWS
2 1/2 PO TÊTE TRONCONIQUE no 8 (no 2 ROBERTSON)

(I) 28X

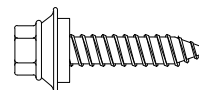

1" #10 METAL ROOF SCREW (1/4" HEAD)
1PO TOITURE DE METAL no 10 (TÊTE DE 1/4 po)

(P) 16X

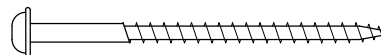

2" PAN HEAD ROBERTSON SCREWS (#2 ROBERTSON)
2 PO À TÊTE TRONCONIQUE no 8 (no 2 ROBERTSON)

ATTACH THE TWO WALL FILLERS (DC 1884) TO TWO CORNER POSTS. NOTE THE SCREW LOCATIONS IN THE DIAGRAM.

WALL FILLERS ARE TO BE FLUSH WITH THE INSIDE OF THE POST AND FLUSH AT TOP AND BOTTOM.

! **P 2" SCREWS**

CRITICAL TO USE 2" SCREWS FOR FASTENING POSTS TO PANELS

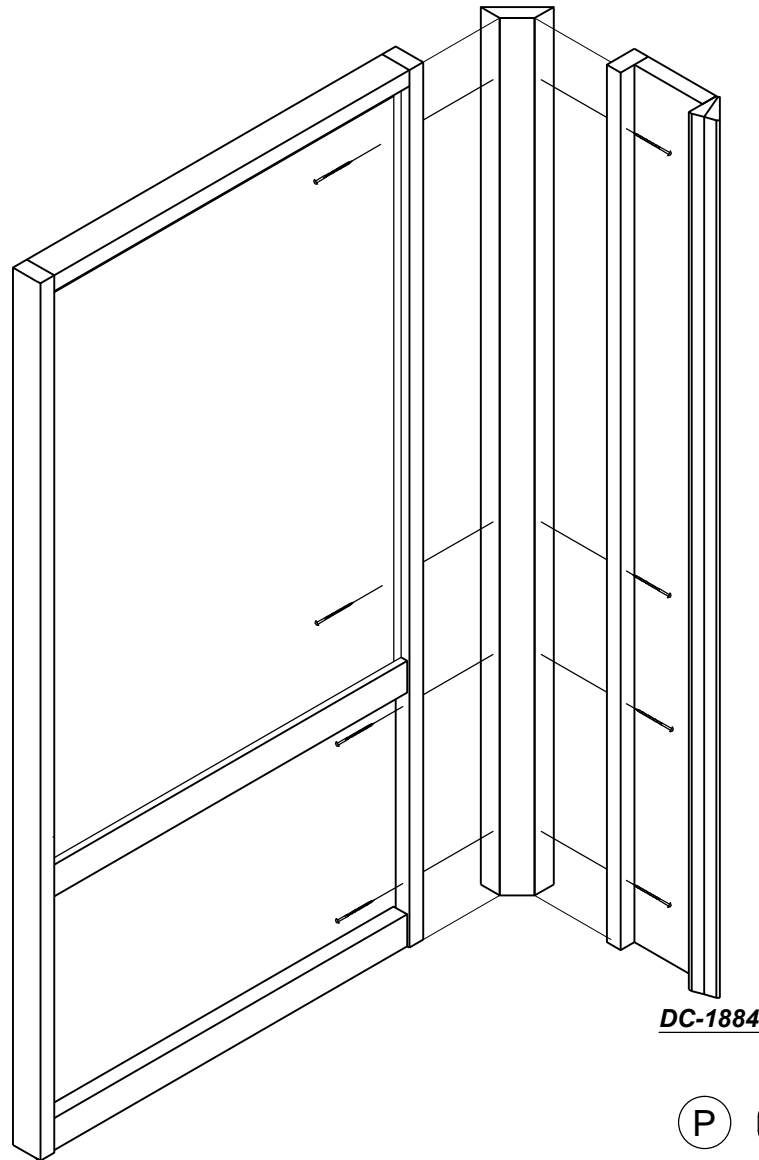
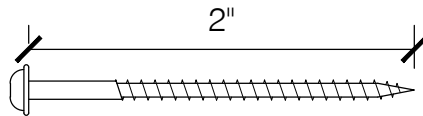

DC-1884

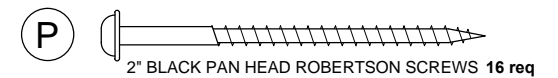

FASTEN ANGLER FILLERS (DC 2070) TO THE WALL PANELS THAT WILL BE ON THE BAY SIDE.

FASTEN THE REMAINDER OF THE WALL PANELS. CONTINUE USING THE SAME SCREW PATTERN FROM THE PREVIOUS STEP.

WALL PANELS ARE TO BE FLUSH WITH EACH OTHER AND FLUSH AT TOP AND BOTTOM.

REFERENCE MARK

REFERENCE MARK

DC-1884

DC-2070

DC-2070

DC-1884

REFERENCE MARK

REFERENCE MARK

! (F) 2 1/2" SCREWS

CRITICAL TO USE 2 1/2" SCREWS FOR FASTENING THE PANELS TOGETHER.

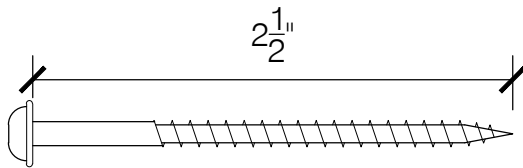

! RETURN TO MANUAL

RETURN TO THE MANUAL FOR ASSEMBLY OF THE ROOF.

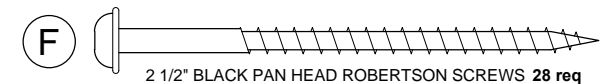

ATTACH THE 2X3 BAY HEADER (DC 2239) TO THE 2X4 BAY HEADER (DC 2238).

FLUSH BOTH ENDS AND THE BOTTOM ENDS.

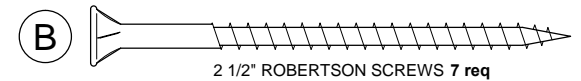
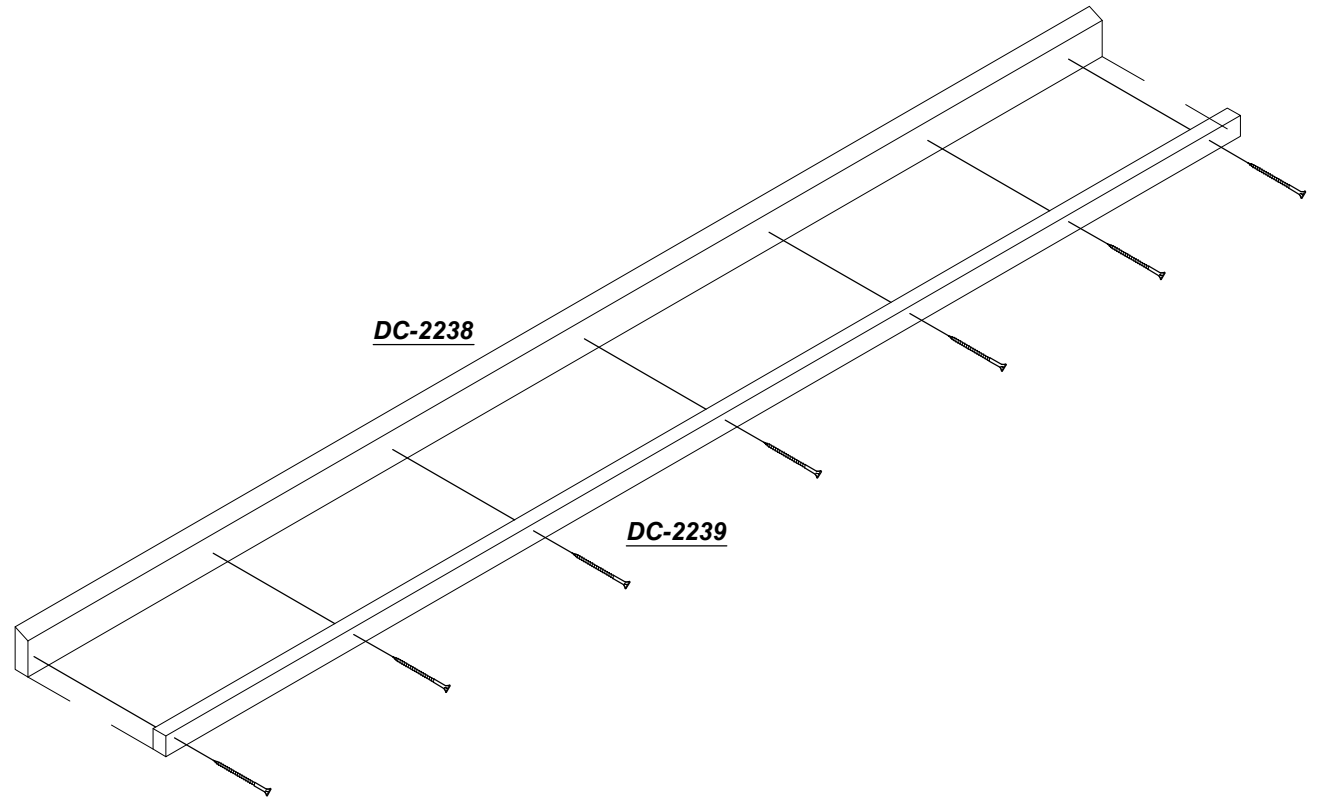
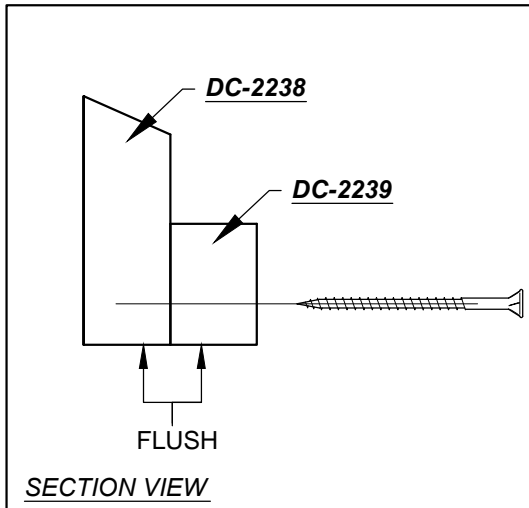

ATTACH THE BAY HEADER ASSEMBLY TO THE TRUSS FRAME.

FLUSH THE BOTTOM EDGE OF THE BAY HEADER ASSEMBLY WITH THE BOTTOM OF THE TRUSS FRAME.

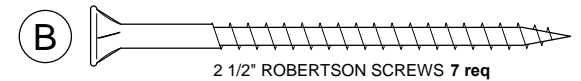
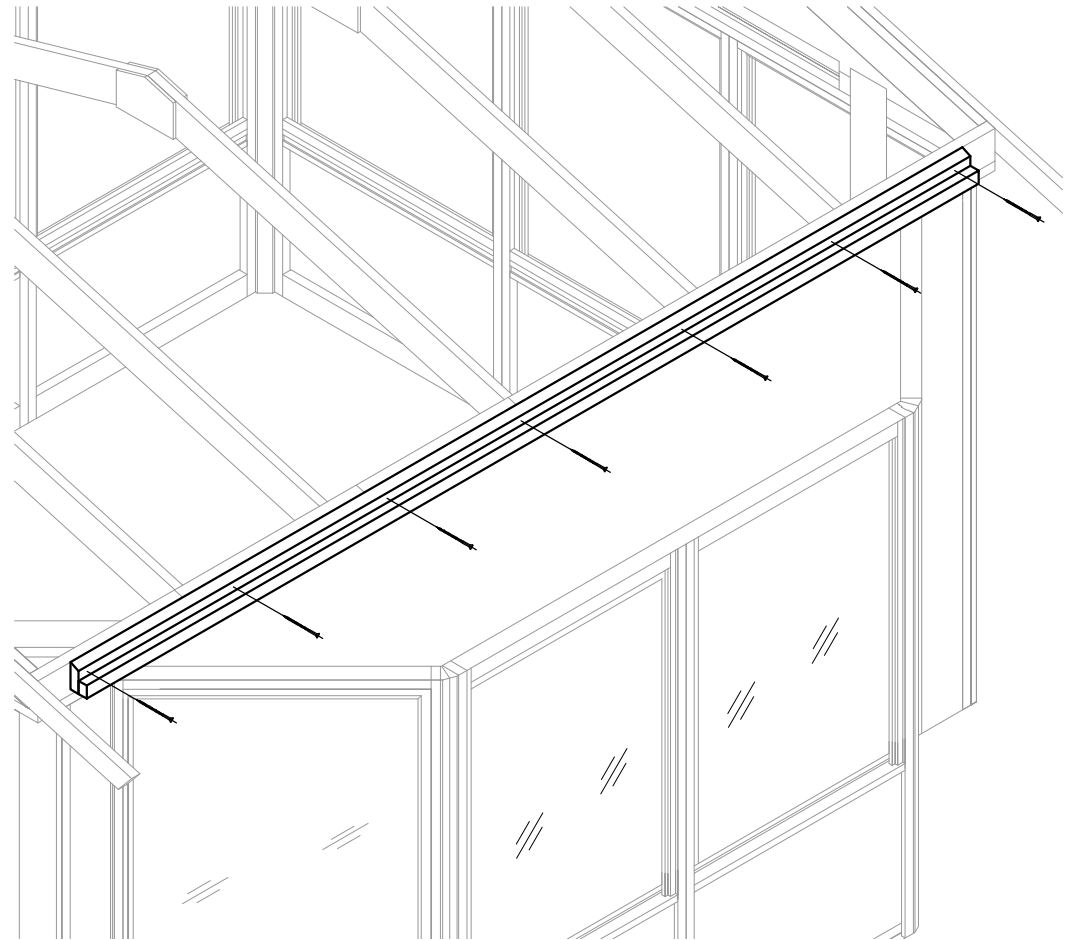
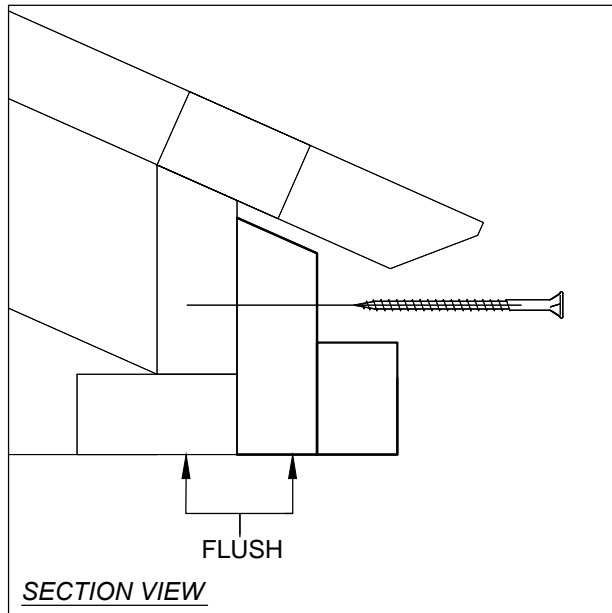

FASTEN THE BAY ANGLE ROOF SUPPORTS (DC 1881) TO THE TOP OF THE WALL PANEL.

THE NOTCH IS TO FACE THE INSIDE OF THE STRUCTURE.

FLUSH THE ANGLE ROOF SUPPORTS TO THE OUTSIDE OF THE WALL PANEL AND TIGHT TO THE BAY HEADER ASSEMBLY.

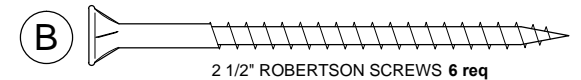
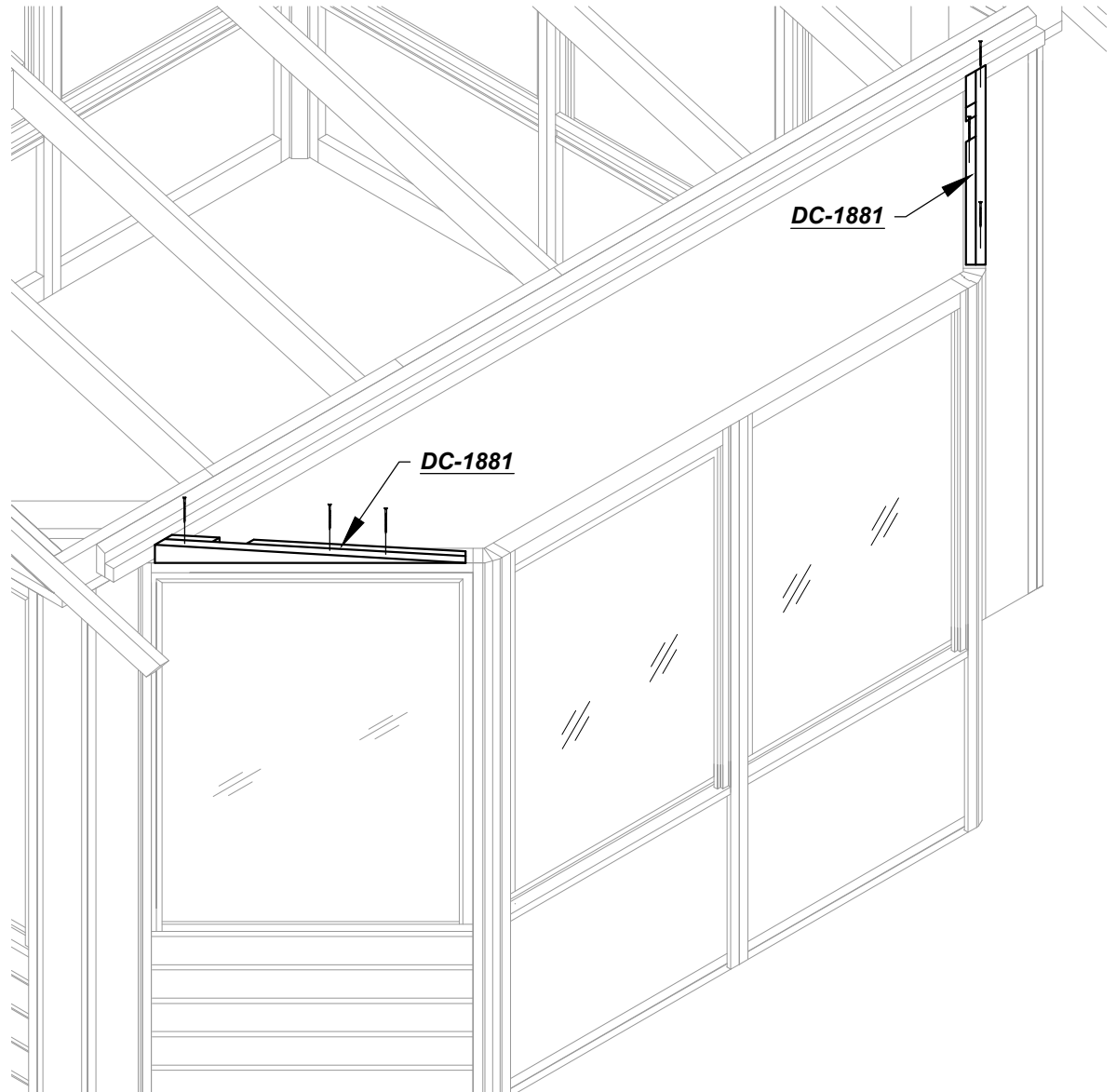

PLACE THE BAY ROOF STRAP (DC 1890) IN THE NOTCH OF THE BAY ANGLE SUPPORTS.



RETURN TO MANUAL

RETURN TO THE MANUAL FOR ATTACHMENT OF THE ROOF PANELS.

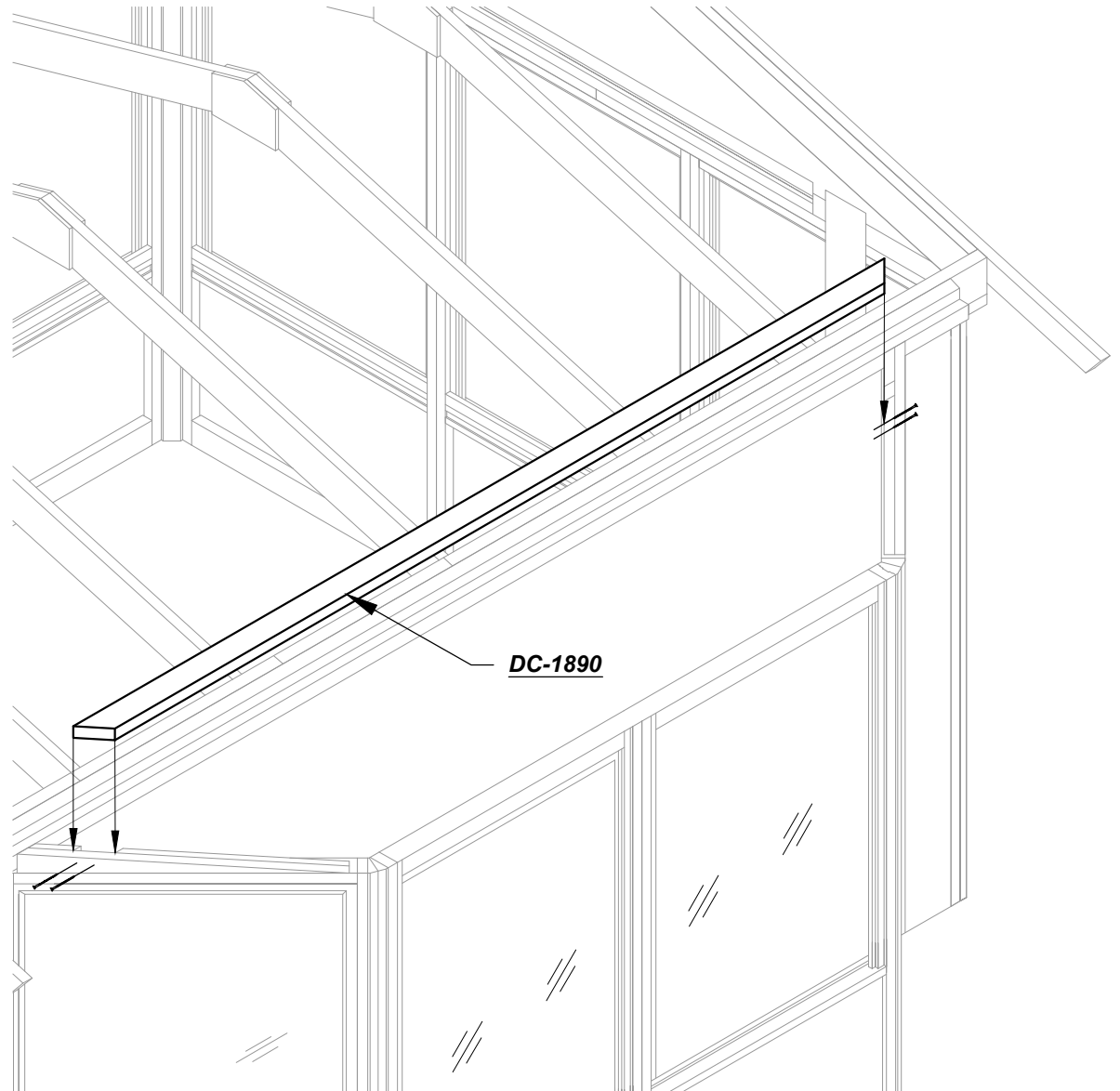

(B)

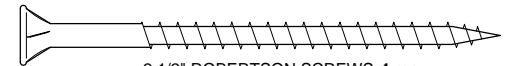

2 1/2" ROBERTSON SCREWS 4 req

PLACE THE EXPANDING FOAM (DC 1644) ALONG THE OUTSIDE EDGE OF THE BAY.

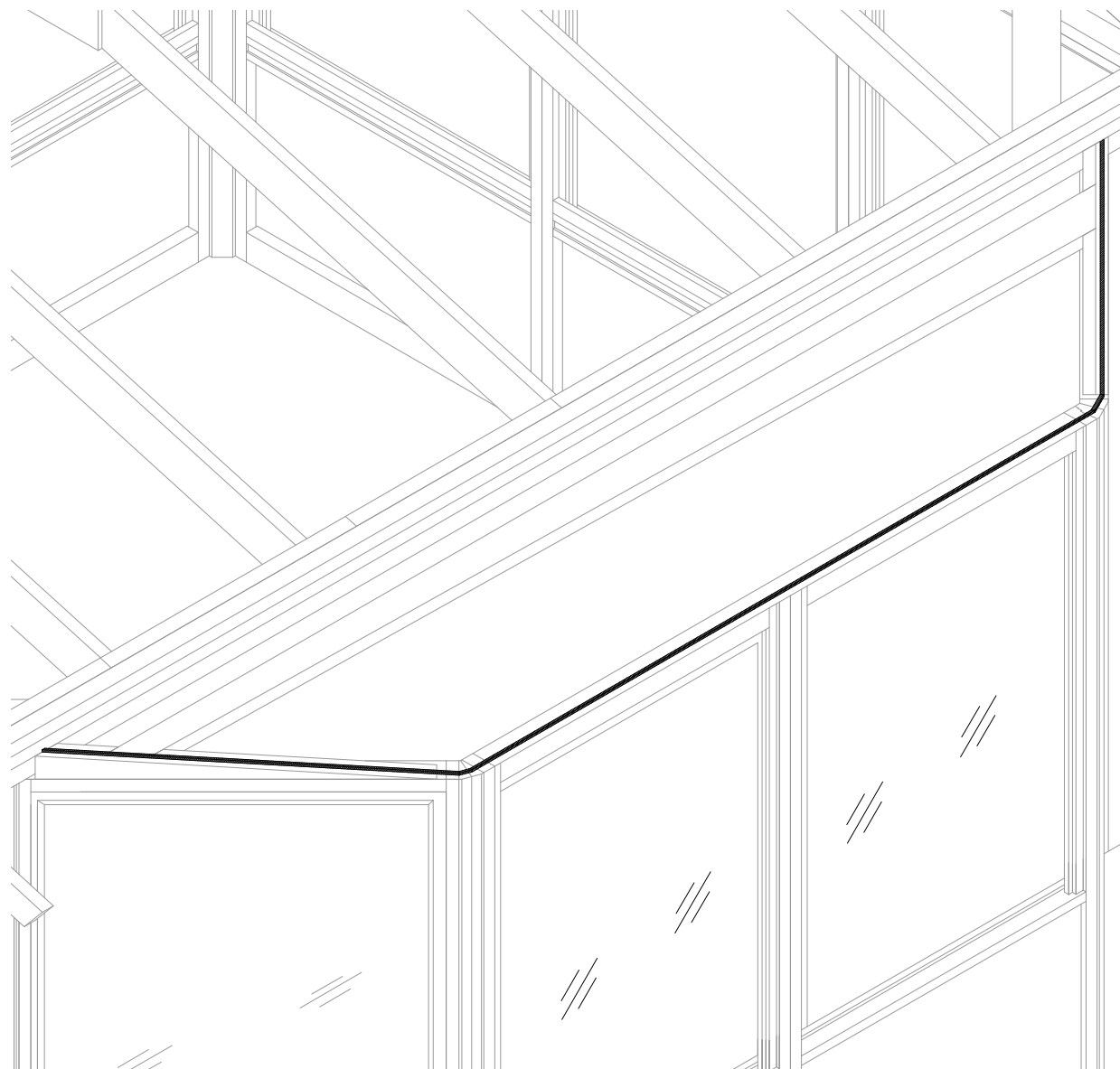

DC-1644

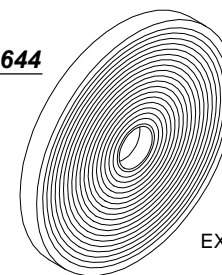

EXPANDING FOAM

LAY THE ROOFING SHEETS (DC 1885, 1886, 1887) ON THE BAY STRUCTURE.

ALIGN THE BAY ROOF PROFILE WITH THE STRUCTURE'S ROOF PROFILE.

FASTEN THROUGH THE WOOD STRUCTURE ONLY.

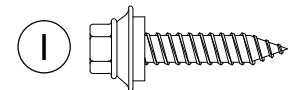
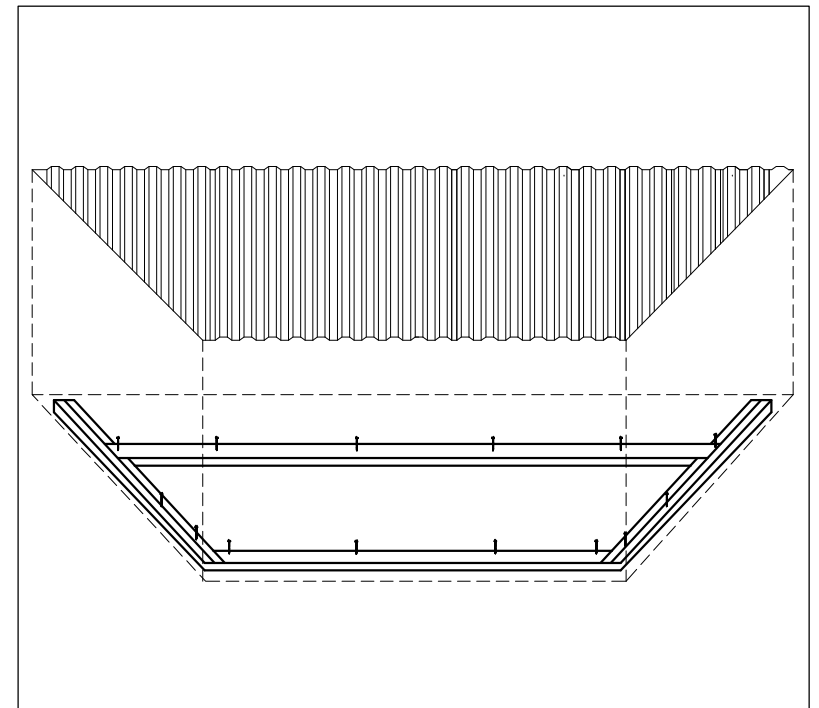
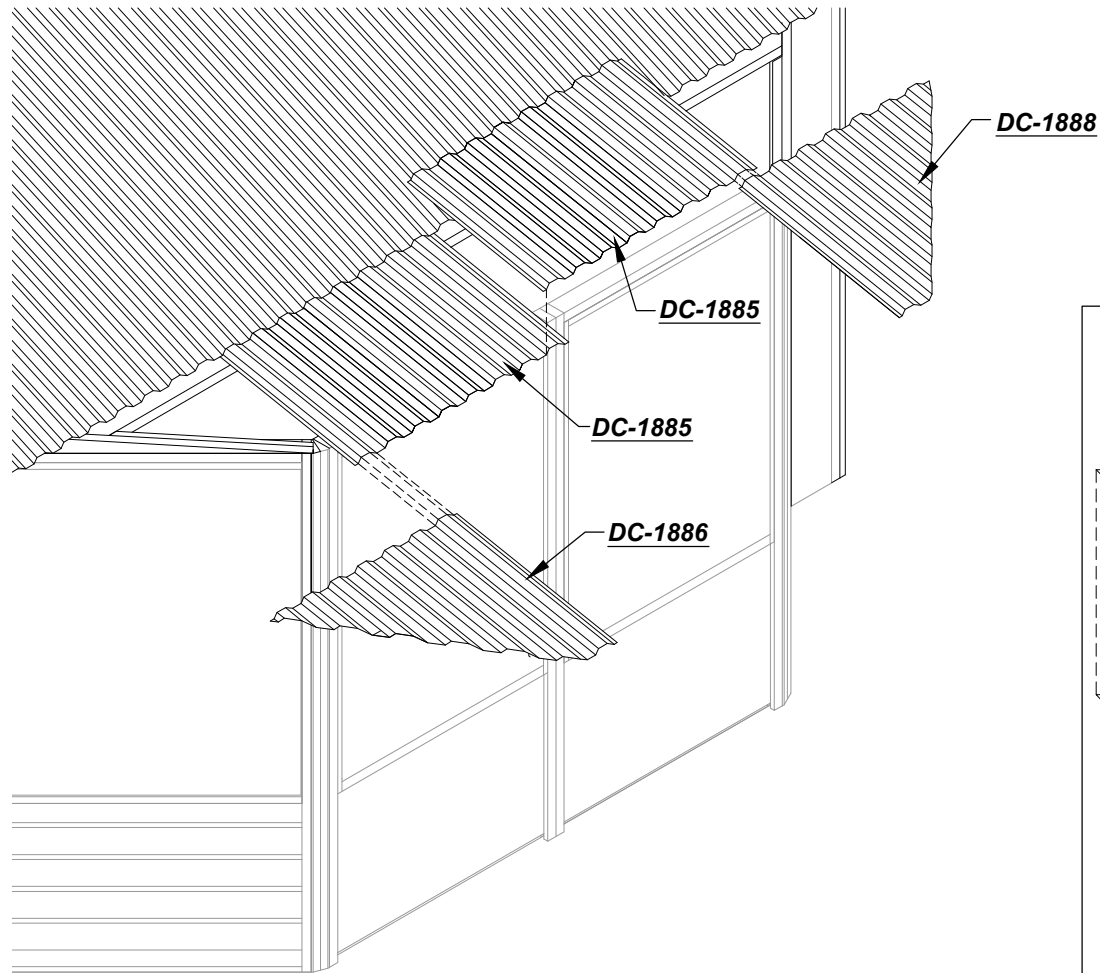

1" ROOF SCREWS 28 req